

REV.	DESCRIPTION	DRAWN	CHECKED	APPROVED
A	NEW RELEASE	YCH 01/07/10'		

NOTES:

- ELECTRICAL CHARACTERISTICS:
 - CONTACT RESISTANCE: 20mΩ Max. INITIAL.
 - DIELECTRIC WITHSTANDING VOLTAGE: 500V AC(rms) FOR 1 MINUTE.
 - INSULATION RESISTANCE: 1000MΩ Min.
- ENVIRONMENT CHARACTERISTICS:
 - OPERATING TEMPERATURE: 0°C~+85°C.
 - STORAGE TEMPERATURE: -20°C~+70°C.
- PART NUMBER: DS1011-06
- PRODUCT NUMBER CODE: DS1011-06- X X X X X X

LOCK DIM.
7: 7.90mm(standard)
4: 4.50mm(special)

HOUSING COLOR
B:Black
A:Gray

CONTACT PLATING
Si: Full Gold flash
Ti: Selective Gold Flash

HOUSING TYPE
B: BIG LATCH HOUSING

MOUNTING TYPE
S: STRAIGHT
R: R/A

No.OF CONTACTS
10 14 16 20
26 30 34 40
50 60 64

SERIES No.
DS1011-06 SERIES

AVAILABLE DIMENSION TABLE

No.of Contacts	10	14	16	20	26	30	34	40	50	60	64
A	32.1	37.18	39.72	44.80	52.42	57.50	62.58	70.20	82.90	95.60	100.68
B	22.20	27.28	29.82	34.90	42.52	47.60	52.68	60.30	73.00	85.70	90.78
C	10.16	15.24	17.78	22.86	30.48	35.56	40.64	48.26	60.96	73.66	78.74
D	18.10	23.18	25.72	30.47	38.42	43.50	48.58	56.20	68.90	81.60	86.68

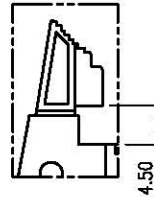
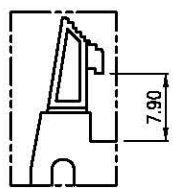
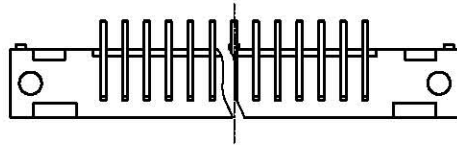
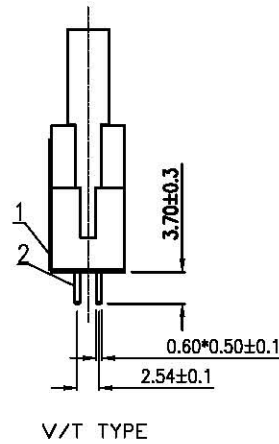
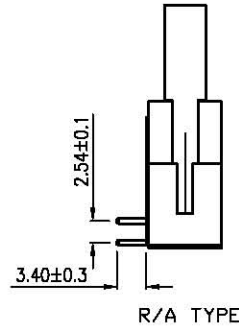
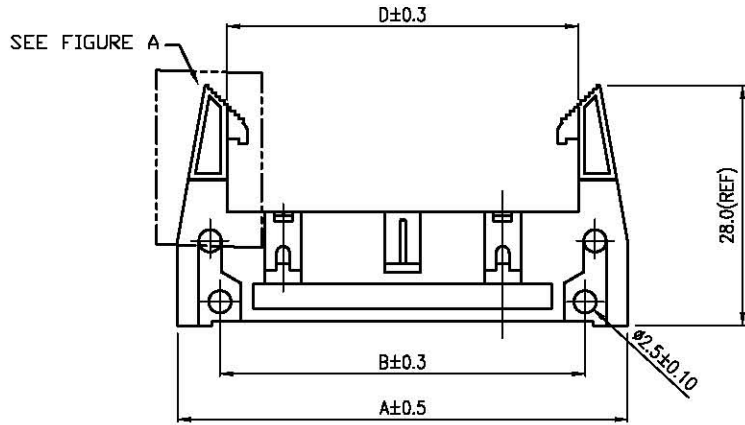
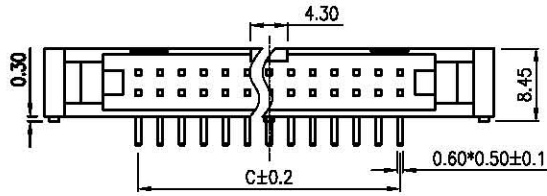

STANDARD LATCH

SPECIAL LATCH

FIGURE A

GENERAL TOLERANCE		ANGLE TOLERANCE	
X.	±0.60	X.	±5°
.X	±0.38	.X	±3°
.XX	±0.25	.XX	±2°

PROJECTION		TITLE	SHOUED HEADER PITCH 2.54mm
UNITS	mm		
SHEET SIZE	A4	SERIES	DS1011-06 SERIES

2	CONTACT		COPPER ALLOY	GOLD PLATED	DRAWING TYPE	CUSTOMER		
1	HOUSING		THERMOPLASTIC	UL 94 V-0	SCALE	1:1	SHEET	1 OF 1
ITEM	PART NAME	PART NO.	MATERILAS	FINISHED	DRAWING NO.	C-DS1011-06-XXBXXX-A		

广东中南电子电器有限公司

www.zn-cn.com